

ESCALA / SCALE 1:80

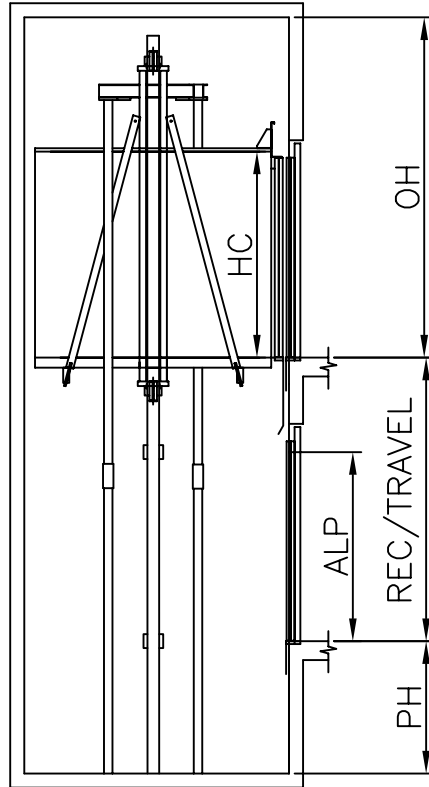

ESCALA / SCALE 1:40

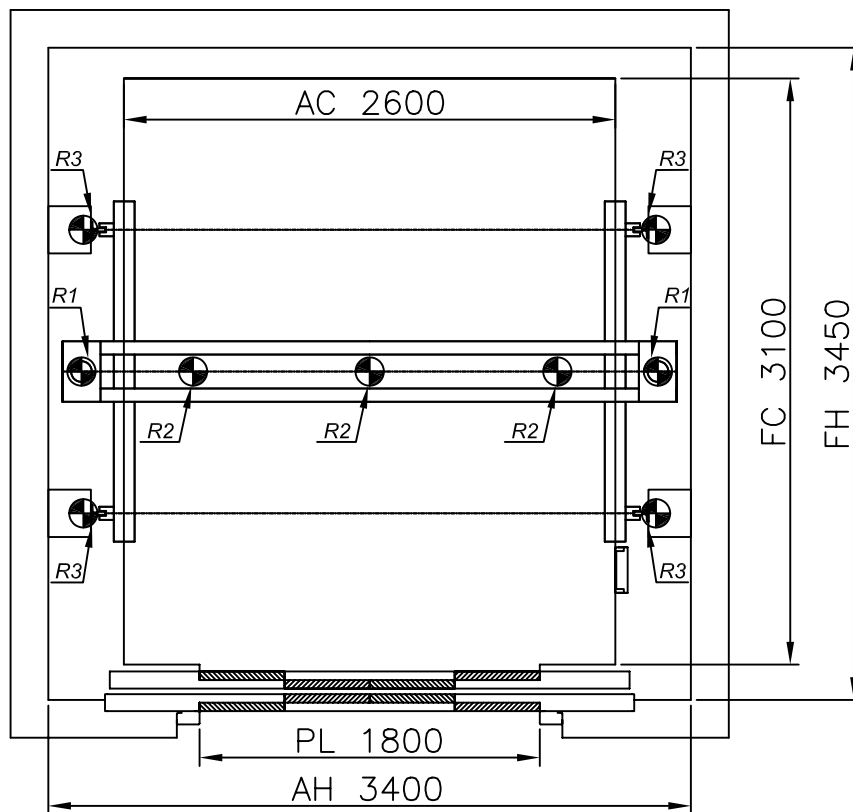

MP 6005 H "C" 1:1

4500 Kg

ACCIONES SOBRE EL HUECO / SHAFT REACTIONS

60P.

R1	CARGA EN PISTÓN / JACK LOAD	53000 N
R2	CARGA EN PUFFER / BUFFER LOAD	95000 N
R3	CARGA EN GUÍA / GUIDE LOAD	64000 N
	REACCION DE GUIAS Sx / GUIDES REACTIONS Sx	5700 N
	REACCION DE GUIAS Sy / GUIDES REACTIONS Sy	9550 N

0.5 m/s

FOSO / PIT HUIDA / OVERHEAD

1400

3600



60 Kw

ESCALA / SCALE 1:80

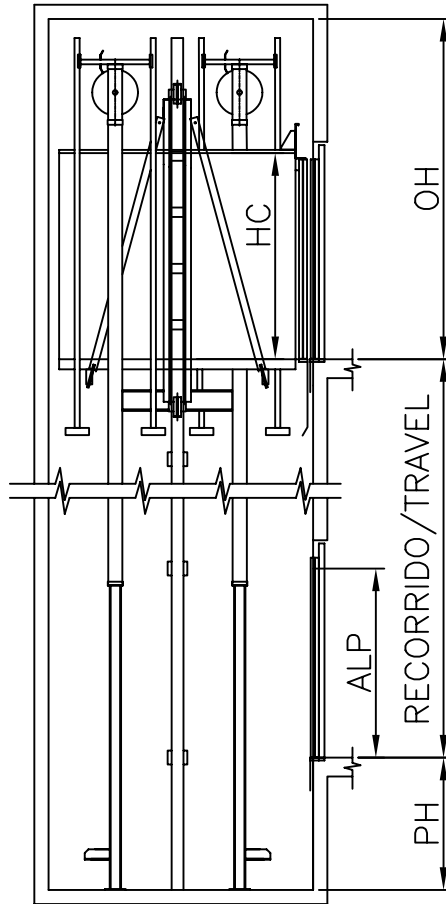

ESCALA / SCALE 1:40

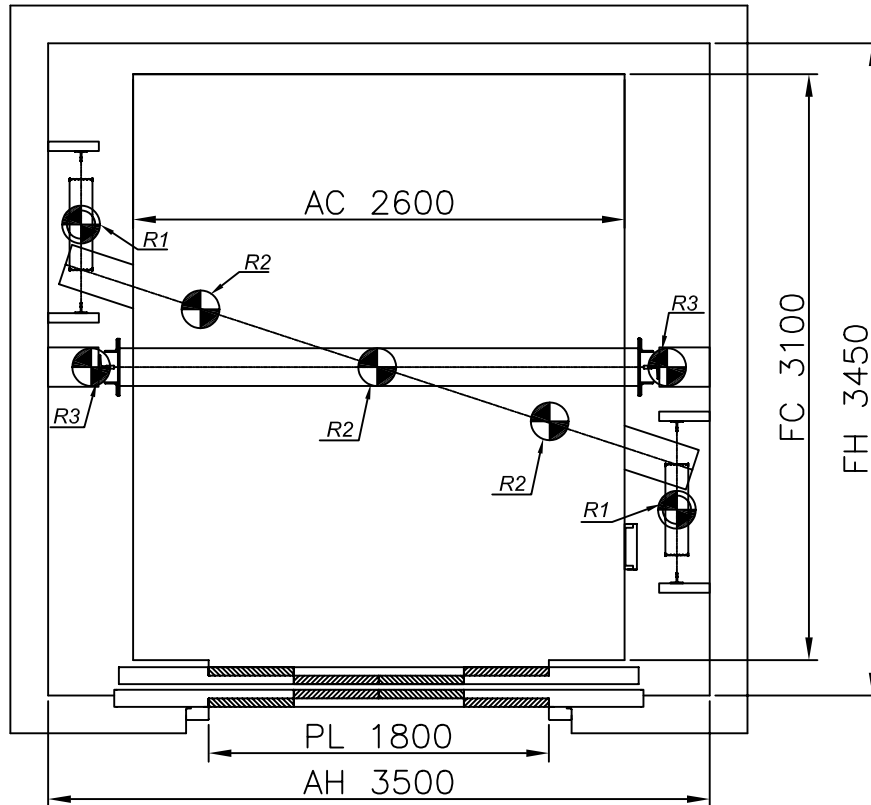

MP 6005 H "C" 2:1

4500 Kg

ACCIONES SOBRE EL HUECO / SHAFT REACTIONS

60P.

0.5 m/s



R1	CARGA EN PISTÓN / JACK LOAD	112600 N
R2	CARGA EN PUFFER / BUFFER LOAD	101370 N
R3	CARGA EN GUÍA / GUIDE LOAD	63000 N
	REACCION DE GUIAS Sx / GUIDES REACTIONS Sx	7120 N
	REACCION DE GUIAS Sy / GUIDES REACTIONS Sy	12000 N

FOSO / PIT

HUIDA / OVERHEAD

1400

3600

59 Kw