

ESCALA/SCALE 1:100

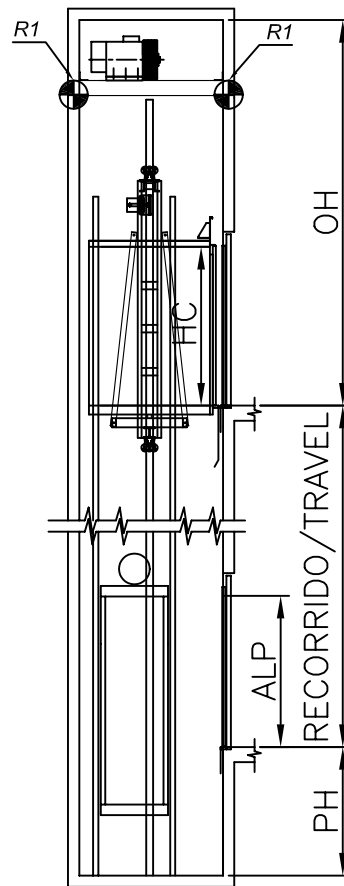

ESCALA/SCALE 1:40

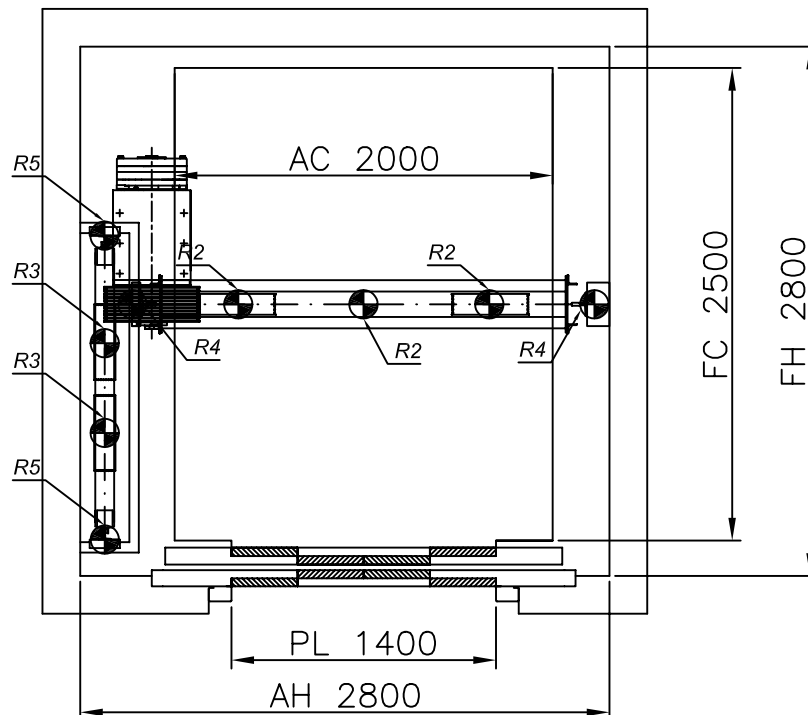

**ACCIONES SOBRE EL HUECO**

**MP3325 GO! "S"**

R1	CARGA SOBRE PARED / WALL LOAD	80000 N
R2	CARGA EN PUFFER CAB / CAR BUFFER LOAD	60000 N
R3	CARGA EN PUFFER CPSO / CTW BUFFER LOAD	65000 N
R4	CARGA EN GUÍA CAB / CAR GUIDE LOAD	44100 N
R5	CARGA EN GUÍA CPSO / CTW GUIDE LOAD	2000 N
	REACCION DE GUIAS Sx / GUIDES REACTIONS Sx	2292 N
	REACCION DE GUIAS Sy / GUIDES REACTIONS Sy	3667 N

2500 Kg	2,5 m/s
33 P.	GO! NOA
FOSO/PIT	HUIDA/OVERHEAD
1700	5100



42 Kw